

FORMAX[®]

Cut-True 27S Semi-Automatic Electric Paper Cutter

MAINTENANCE MANUAL
SECOND EDITION

TABLE OF CONTENTS

TOPIC	PAGE
Specifications	1
Safety Guidelines	1
Installation / Assembly	2
Overview	3
Description of Equipment Parts	3 - 4
Operation	4
Replacing the Cutting Stick	5
Adjusting Blade Height - Cutting Depth	5
General Maintenance	5
Cutting Blade Maintenance	6
Troubleshooting	6
Replacing the Cutting Blade	6 - 8
Maintenance	9 - 11

Cut-True 27S Guillotine Cutter



SPECIFICATIONS

Cutting Action:	Dual-button electric
Maximum Cutting Width:	18.9" (480mm)
Maximum Paper Stack Height:	3.15" (80mm)
LED / Laser Cut Line:	Yes
Clamp Style:	Automatic
Back Gauge Adjustment:	Manual crank
Back Gauge Reading:	Digital readout, in both inches and metric
Blade Change Safety Tool:	Included
Dimensions:	51" H x 36" W x 39" D (1300mm H x 920mm W x 1000mm D)
Weight:	595 lbs.
Power Supply:	110V
Safety Certifications:	CE approved, UL pending
Metal Stand with Shelf:	Included, some assembly required

SAFETY GUIDELINES

- * Operators should read this manual prior to using the cutter.
- * The Cut-True 27S should only be used by one person at a time.
- * Keep hands away from the cutting area. The cutter is operated by pressing two "enable switches" simultaneously.
- * Do not disassemble Plexiglas safety covers, and never attempt to change the settings of any protective devices.
- * Do not grasp underneath the blade edge.
- * When changing the blade, carefully follow the instructions in this manual, and be sure to use the supplied Blade Change Safety Tool. Wear leather gloves to provide additional safety.
- * The Cut-True 27S is designed to cut only paper. DO NOT attempt to cut non-paper materials including metal sheets, wood, plastic or anything other than paper. Machine damage and/or personal injury may occur.
- * Be sure to check the safety devices before each operating session.

INSTALLATION

Please use caution when moving the cutter, and be sure to utilize appropriate lifting devices when attaching to the stand.

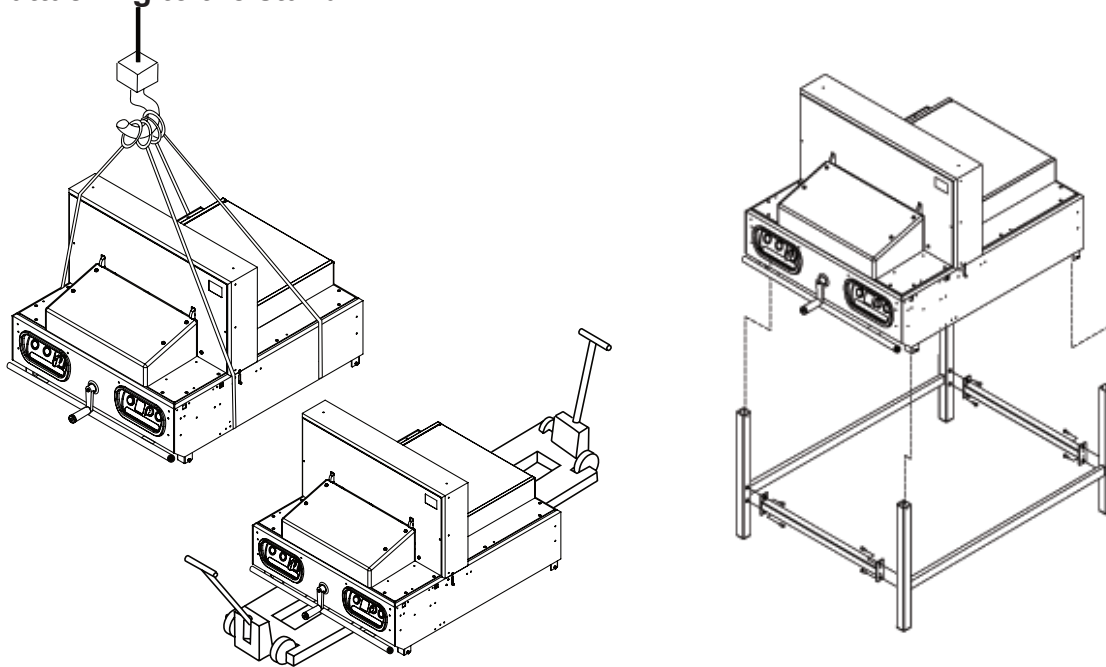

The cutter can be moved by using an overhead motorized lift, pallet jacks, or by hand.

NOTE: Four people are required to move the cutter by hand.

To move the cutter by hand, utilize the lifting handles located on the front and back of the machine. To adjust the handles, loosen the knobs on the underside and slide the handles to out to a comfortable position. Retighten the knobs.

When the cutter is in place and securely attached to the stand, loosen the knobs, adjust the handles to their storage position and tighten the knobs.



Lifting handle



Adjustment knob

Adjustment knob

Lifting handles

ASSEMBLY

The side panel, wooden paper pusher, blade safety device, and back gauge crank with screw are packed separately in the box with the machine. Please set these aside and install after connecting the cutter to the stand.

The cutter should be installed in a location with sufficient space to permit efficient assembly, operation and maintenance. Do not install in locations with direct sunlight or near a heat source.

The chassis and stand of the machine should be connected as follows:

1.	Set the legs so the 4 threaded pins point upward.
2.	Assemble the crossbars of the stand so the color labels on each match the corresponding legs. Fasten stand securely with hexagonal screws.
3.	Place the chassis correctly onto the assembled stand.
4.	Tighten the four hexagonal nuts.
5.	Position stand shelf in place and fasten securely with enclosed screws.

OVERVIEW

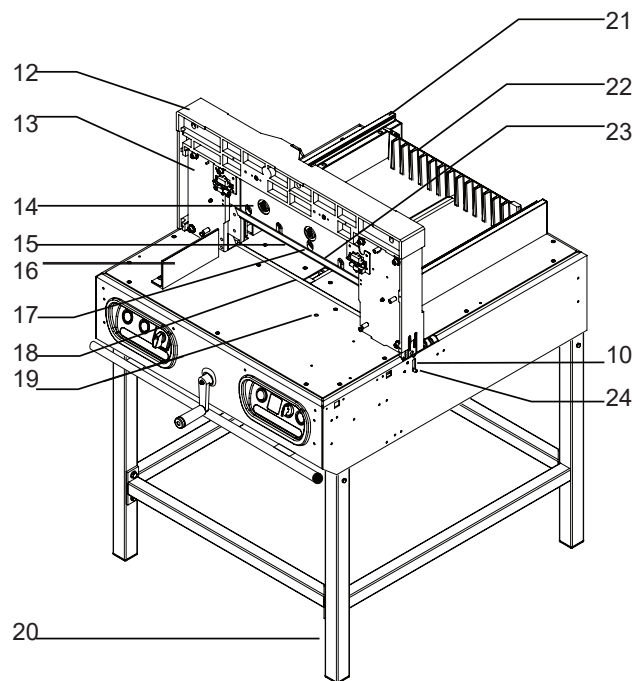
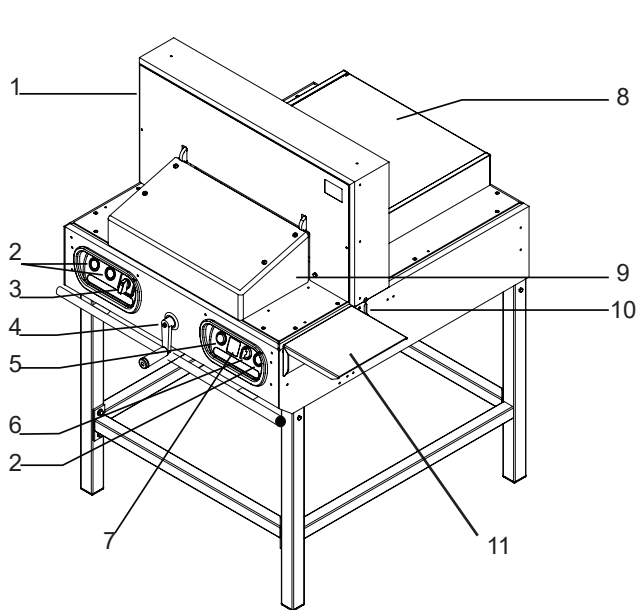



DESCRIPTION OF EQUIPMENT PARTS

1.	Cover	Attached to the cutter with four screws. Disassemble only in case of blade change or maintenance.
2.	Enable Switches	These switches must be pushed simultaneously to operate the paper clamp and cutting blade.
3.	Power Switch	Used to turn on and off power to the cutter.
4.	Back Gauge Crank	Used to adjust back gauge to appropriate paper size and cut length. It is indirectly connected with the Back Gauge: to engage the crank, simply push it towards the machine, then turn. To release, pull the crank toward the operator. To move the back gauge toward the operator, turn clockwise. To move the back gauge away from the operator, turn counterclockwise.
5.	Power Light	Shows when machine is powered on.
6.	Key-Activated Mode Select Switch	Turn to right for cutting. Turn to left for blade replacement. Turn to middle to stop all operations.
7.	Digital Measurement Readout	Shows the current position of the back gauge, in mm and inches.
8.	Rear Safety Cover	Clear plexi cover is provided for operator safety and helps to prevent dust buildup.
9.	Front Safety Cover	Prevents operators from placing hands or other objects in the cutting area. Must be in the lowered/closed position in order to operate the cutter. The guard can only be reopened when the blade is in the upright position.
10.	Side Interlock Device A	The cutter will not operate if the 6mm T-wrench used for blade adjustments is still in the adjustment slot.
11.	Side Panel	Additional workspace.
12.	Carrier (support)	Carries the blade holder and the entire mechanism of the machine.
13.	Safety Interlock Device B	The machine can only be operated when the safety guard is closed.
14.	Three Socket Headless Screws	Adjustable screws for even cutting.
15.	Cutting Blade	Made of high-quality carbon steel.
16.	Paper Alignment Bars	Steel side bar helps to align the paper prior to cutting.

17.	Blade Holder	Holds blade in place. There are five screws for blade positioning, (which should be set up and released step-by-step following the blade replacement instructions) and adjusting the blade for even operation.
18.	Cutting Stick	Plastic stick which protects the edge of the blade during cutting. Can be repositioned and used on all four sides before being replaced.
19.	Cutting Stick Access Slot	Insert screwdriver here in order to lift and remove cutting stick.
20.	Stand	Steel stand, assembly required.
21.	Side Gauge with Scale	In mm/cm and inches. The indicator on the back-gauge shows the measurement. Fine adjustment is done via the back gauge crank (4). Minimum adjustment is 0.5mm.
22.	Back Gauge	This is moved by rotating the Back Gauge Crank. Used to move the paper stack into the appropriate cutting position.
23.	LED Laser Cutting Line	Shows operator exactly where the blade will cut the paper stack.
24.	Blade Adjustment Access	The blade height can be adjusted up to 2mm by using the adjustment screw. To lower the blade (+), turn to the left. To raise the blade (-), turn to the right. NOTE: If the blade is adjusted too low, it will cut deeply into the cutting stick, damaging not only the stick but the cutting blade. The optimal blade height is when the last sheet in a stack is cut accurately.
	Wooden Push Block (not shown)	Used to help align paper stacks for precise cutting.
	Blade Change Safety Tool (not shown)	This device is used to safely remove the blade when it needs to be sharpened or replaced.
	Tool Kit (not shown)	Includes T-wrench and interchangeable bits for use in adjustments and blade replacement.

OPERATION

1. Plug in the cutter to an appropriate power outlet.
2. Turn on the red power switch.
3. "HOME" the machine once powered on. Turn/crank handle to move gauge all the way back until it stops, then slightly forward. The flashing display will now display numbers.
4. Raise the front safety cover. Slide the paper stack into the cutter along the left edge, using the alignment bar for guidance. Push it as far back as possible toward the back gauge, without placing hands under the cutting blade.
5. To change the back gauge LED readout between standard (inch) and metric (cm), insert a pin or straightened paper clip into the access hole just above the LED, as shown in the diagram at right. *
6. Push in the back gauge crank to engage the handle, then turn it clockwise to bring the back gauge toward the front until the paper is properly matched with the measurement guide on the side of the machine. The LED digital readout will indicate the position of the cut. The LED Laser Light will indicate the position of the blade to help with paper positioning.
7. Release the back gauge crank handle by pulling it toward you. This disengages the crank and prevents unintentional movement.
8. Use the wooden push block to align the front and right edges of the paper stack.
9. Lower the front safety cover.
10. Turn the Mode Select Switch key to the right.
11. Press and hold the two clamp engage switches to clamp the paper securely in place. The clamp switches are indicated by this icon 
12. Press and hold the two blade engage switches to cut the paper. The blade switches are indicated by this icon . After cutting, the blade and clamp will each return to the upright position.
13. Lift the front safety cover and remove the paper stack.

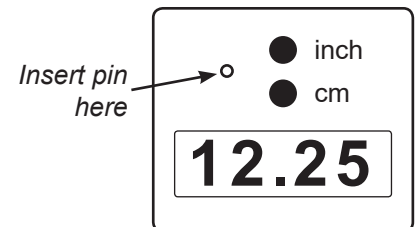

NOTE: If you need to manually re-calibrate the back gauge, follow these steps:

With the cutter powered ON, hand crank the back gauge to line up with 32cm on the SIDE ruler. Press carefully and hold the reset button for 5-8 seconds. The display will change to read 32cm. The cutter is now manually calibrated. (The reset button is the same button used to change the readout from inch to cm.)

ROTATING / REPLACING THE CUTTING STICK

The cutting stick is the surface the blade contacts during the cutting process. It can be rotated and used on each side, 4 times altogether.

If the last piece of paper in the stack is not cut through cleanly, and the blade depth has been adjusted properly, the cutting stick should be rotated or replaced.

The cutting stick sits in a channel in the base of the cutter, just below the blade carrier. To remove it, first turn off the power. Then insert the 5mm screwdriver into the cutting stick access slot (see photo below left) and lift up. Grasp the cutting stick and remove (see photo below right). Rotate the cutting stick to a new side and re-install.

NOTE: When the cutting stick is rotated or replaced, the blade height must be readjusted. See the next page for blade height adjustment instructions.



ADJUSTING BLADE HEIGHT / CUTTING DEPTH

When the cutting stick is rotated or replaced, or the blade is replaced, the blade height must be readjusted. A blade which cuts too deeply damages not only the cutting stick but the blade itself. The optimal blade height is when the last sheet in a stack is cut accurately. The blade height can be adjusted up to 2mm.

1. The blade adjustment access is on the right side of the cutter, just behind the fuse panel (see picture, below left).
2. Slide the finger knob down and hold in place to open the access door.
3. Insert the T-wrench from the tool kit into the adjustment slot. To lower the blade (+), turn to the left. To raise the blade (-), turn to the right.
4. NOTE: You must remove the T-wrench before operating to avoid injury or damage to the cutter.

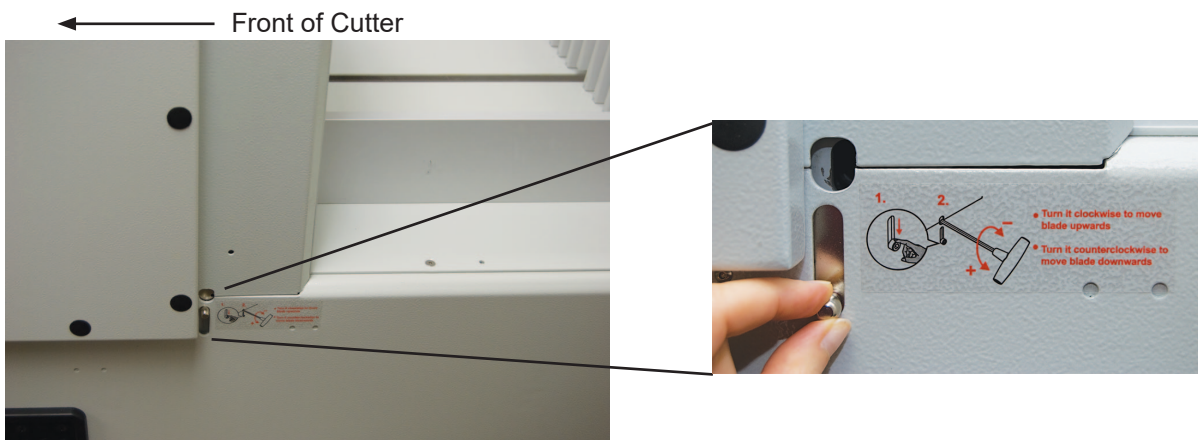

GENERAL MAINTENANCE

All moving parts with screws should be checked periodically to be sure the screws are tight. They may become loose in the process of transportation. Users should also check and tighten the screws after more than 200 cutting cycles.

All moving parts should be lubricated and oiled periodically to maintain performance and equipment life. Before lubricating, these parts should be cleaned to remove paper dust and old deposits of oil and grease.

CUTTING BLADE MAINTENANCE

The cutting blade is made of heat-treated high-carbon steel and is designed for repeated use. However, over time the blade will become dull, and not perform to the highest standards. Cutting heavy paper or cardboard will dull the blade more quickly than thinner paper stock. A dull blade will not cut accurately. Blade lifetime with normal paper is approximately 1,500 cuts (tested in maximum capacity).

NOTE: If the blade jams in the paper stack or leaves a groove in the paper, it should be changed immediately.

If “CUT1500” appears in the LED display, the blade has completed 1,500 cutting passes. Check the blade to see if it is dull or still sharp enough to cut through one sheet of copy paper.

If the blade is still sharp and does not need to be replaced, reset the counter with the following steps:

1. Turn the select switch key to the right.
2. Press and hold the right enable switch for at least 5 seconds, while simultaneously turning the select switch key back to the middle position until the message “CAT” appears in the LED display.
3. Release the right enable switch.

If the blade is not making clean, accurate cuts, check the following:

- * Have you rotated or replaced the cutting stick?
- * Have you correctly adjusted the height of the blade?

If so, the blade will need to be replaced. The blade can either be re-sharpened by a professional, or it can be replaced with a new blade. To avoid injury, follow the Blade Changing Procedure and use the Blade Change Safety Tool, included with the cutter.

TROUBLESHOOTING

Blade doesn't move	Check if the main motor magnetic contact is activated.
No power	Check power source and all control circuit fuses.
Overload	Wait until the breaker automatically resets, which takes around 30-60 seconds. The indicator light will be off. Reduce size of paper stack or change blade.
Cutter won't operate after closing front safety guard	Press the two “enable switches” again, and check if the safety guard is completely closed.
Other issues	Please contact your Formax dealer for service.

Blade Replacement Procedure

1. Remove screws at both ends of the cover. Lift off and remove the cover.



Select switch in blade change position

2. Turn the power switch ON, and turn the select switch to the left.



Power switch in ON position

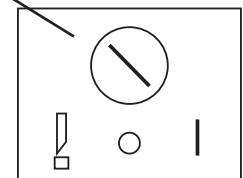

3. Press two enable switches simultaneously to move the blade down to the bottom position.



4. Turn the select switch to the middle and turn off the power. Then lift the plexi safety cover to remove the first screw from the right side of the blade (A).

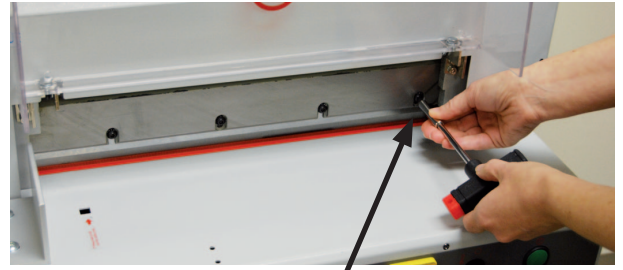

5. Close the safety cover and turn the select switch to the left. Then turn on the power. The blade will move up automatically. Turn the select switch to the middle and turn off the power.

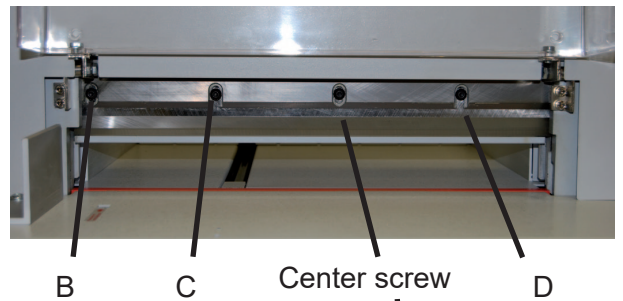

6. Raise the safety cover and remove the first screw from the left side (B). Remove the screws to the left and right of center (C & D), but leave the center screw in place.
NOTE: Do not remove the center screw.

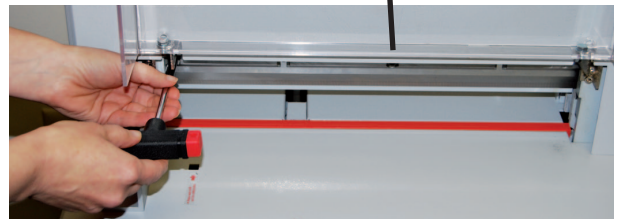

7. Remove the blade change safety tool from the tool box and screw the handles into the two holes to the left and right of center (see photo). Screw them in tightly, to prevent the blade from falling out of the holder.



Blade change safety tool in place

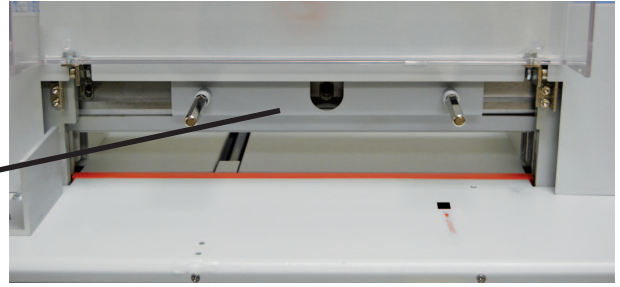

8. Remove the center screw.

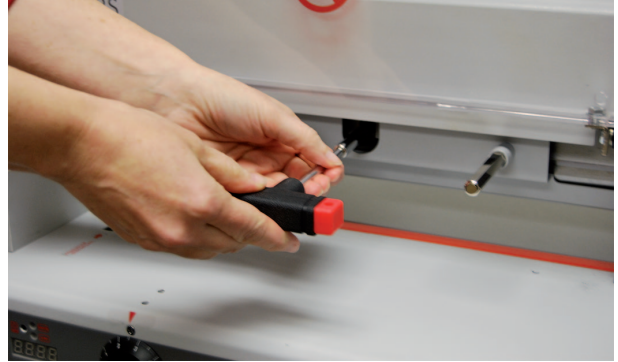

9. Grip and loosen both of the blade change tool handles by turning just a half reverse turn to remove the blade from the machine. Carefully move the blade and holder downward in order to remove it safely from the machine. NOTE: Be careful to avoid injury from the very sharp blade.



10. Carefully remove the old blade from the blade change safety tool. Set it on a flat surface and unscrew the handles. Cap the old blade with a protective pad to prevent injury.

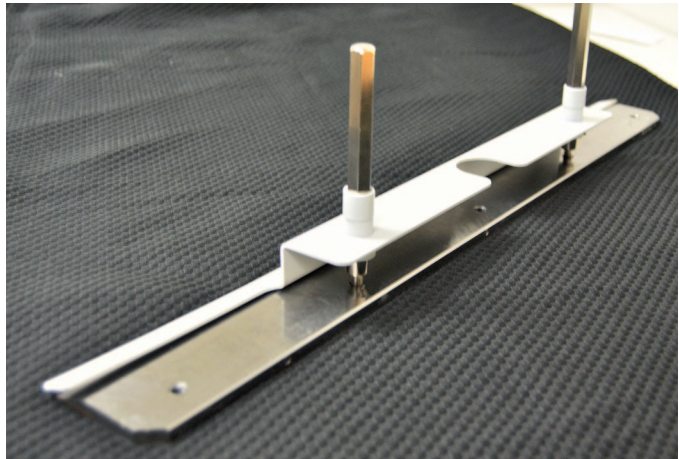

11. Place the new blade with the beveled cutting edge facing up, and the screw holes at the top, as shown here. Remove the protective pad from the new blade.

To attach the blade change tool, place it over the blade and screw the handles into the lower set of screw holes. Then reverse the procedure to install the new blade.

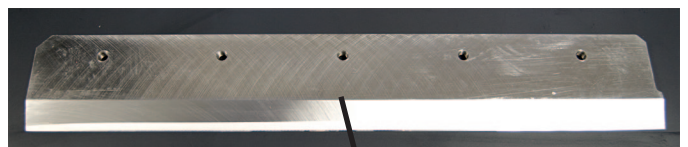

Beveled cutting edge

MAINTENANCE

To access the following internal parts, remove the paper deck cover using the hex nut tool. Then, remove the two panels covering the electrical box.

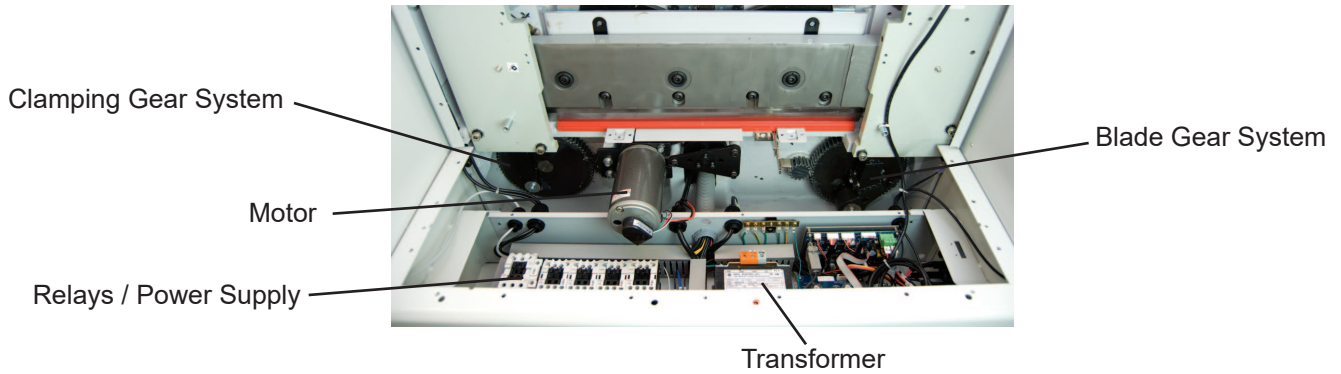

Overload Relays (Fig. 1)

Clamping bar does not move downward	Check Relay KM1 and its auxiliary contact.
Clamping bar does not move upward	Check Relay KM2 and its auxiliary contact.
Blade does not move downward	Check Relay KM3 and its auxiliary contact.
Blade does not move upward	Check Relay KM4 and its auxiliary contact.
Neither clamping bar nor blade will move.	Check KM5, as it is the main power supply for KM1, KM2, KM3 and KM4. If KM5 fails, it will cause each of these relays to fail.

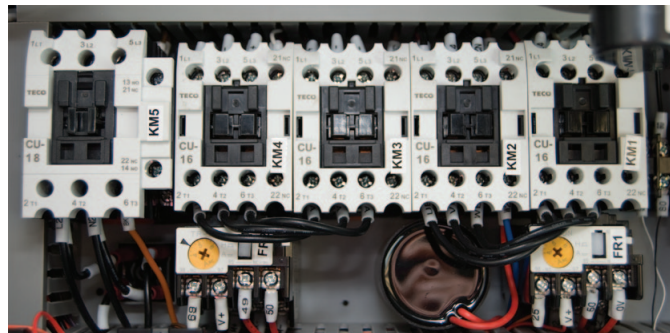

Fig. 1

Blade Gear System

If the blade will not move, check the condition of the Blade Gear System (Fig. 2) which pulls the blade both up and down. The lever may be broken. The primary cause for breakage is that the blade has reached the end of its life cycle and has become dull.

Refer to the instructions on page 6 to replace the blade.

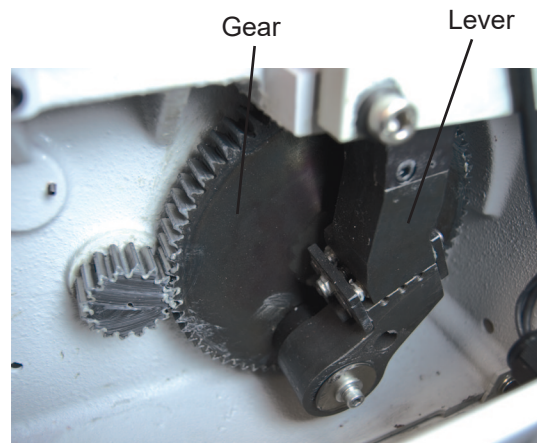

Fig. 2

ERR4 Message

If the control panel shows the message ERR4, it means SQ7 has encountered a problem, or that the blade will not return to its original position in the normal time period. SQ7 is located behind the Blade Gear System (Fig. 2). Check to see if the Blade Gear System is jammed.

Blade will not return to original position

If the blade will not return to its original position, check the function of SQ8. SQ8 is located behind the Blade Gear System (Fig. 2). Check to see if the Blade Gear System is jammed.

Clamping Bar will not function

If KM1 and KM2 are functioning properly, but the clamping bar will not function, check the clamping gear system (Fig. 3) to see if it is jammed.

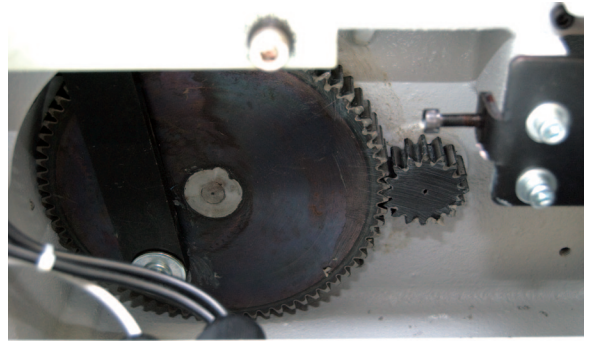

Fig. 3

Blade will not move

If KM3 and KM4 are functioning properly, and the safety key is turned to the blade adjustment position, but the blade will not move, check the blade gear system (Fig. 4) to see if it is jammed.

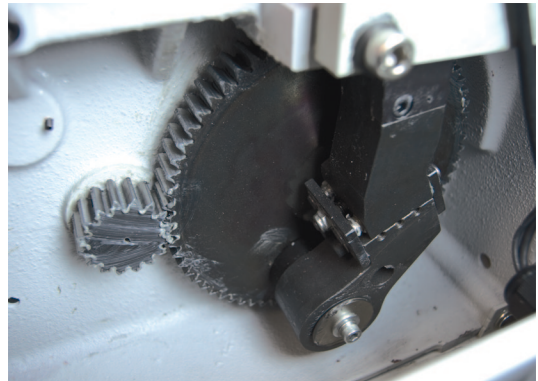

Fig. 4

FR1 Device

If KM5, KM1 and KM2 function properly, but the clamping bar does not work, check the FR1 Device (Fig. 5) which detects the proximity of the clamping bar system.

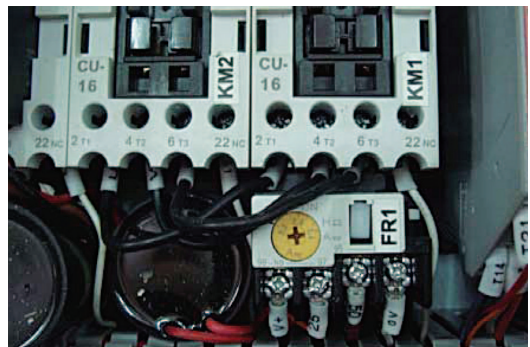

Fig. 5

FR2 Device

If KM5, KM3 and KM4 function properly, but the blade does not work, check the FR2 Device (Fig. 6) which detects the proximity of the blade system.

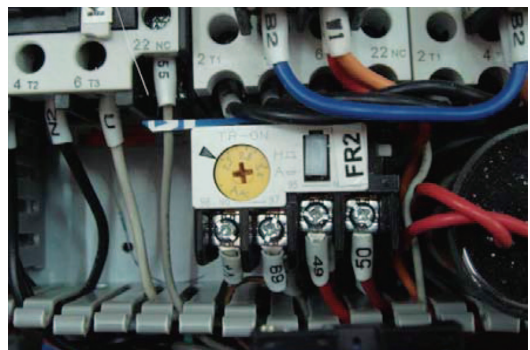

Fig. 6

Fuses FU3 & FU4 Burning Out - Blade Motor

The fuse panel is located on the outside of the cutter, on the right side near the blade change access (page 5).

If fuses FU3 and FU4 (Fig. 7) continually burn out, the blade motor may not be working properly, or the IC board on the blade motor has failed. Check and replace if necessary.

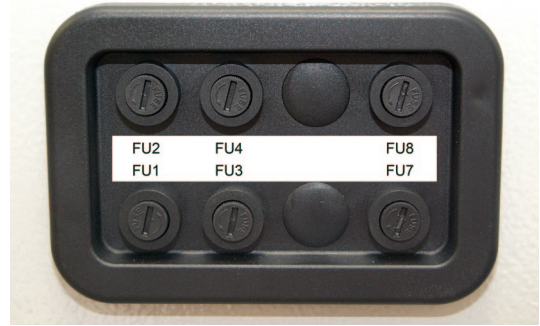

Fig. 7

Fuses FU7 & FU8 Burning Out - Transformer

The fuse panel is located on the outside of the cutter, on the right side near the blade change access (page 5).

If fuses FU7 and FU8 continually burn out, check the transformer (Fig. 8) and repair or replace if necessary.

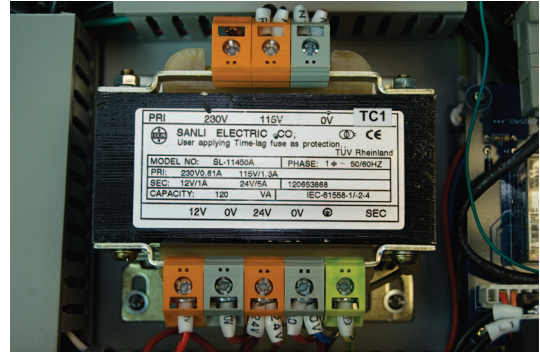
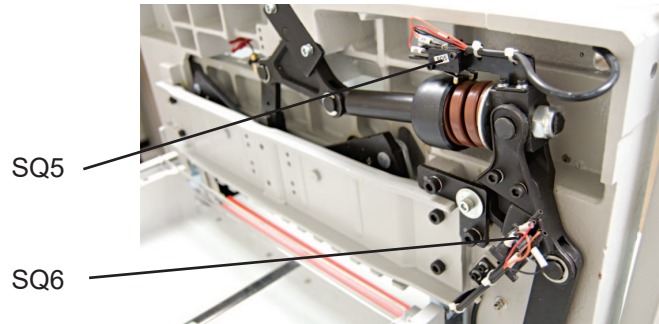

Fig. 8

To access the following internal parts, carefully remove the top cover. These parts are located on the back side of the cutter.



SQ5 Switch

If the clamping bar is functioning properly, but the blade will not raise or lower, check the SQ5 switch (Fig. 9).

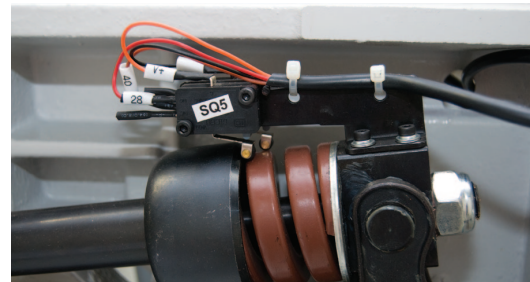

Fig. 9

SQ6 Switch

If the blade is functioning properly, but the clamping bar will not raise or lower, check the SQ6 switch (Fig. 10).

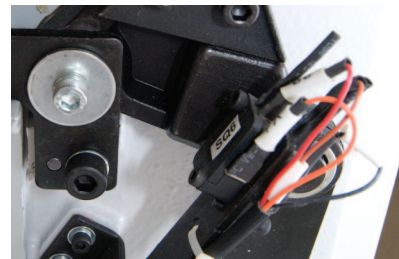
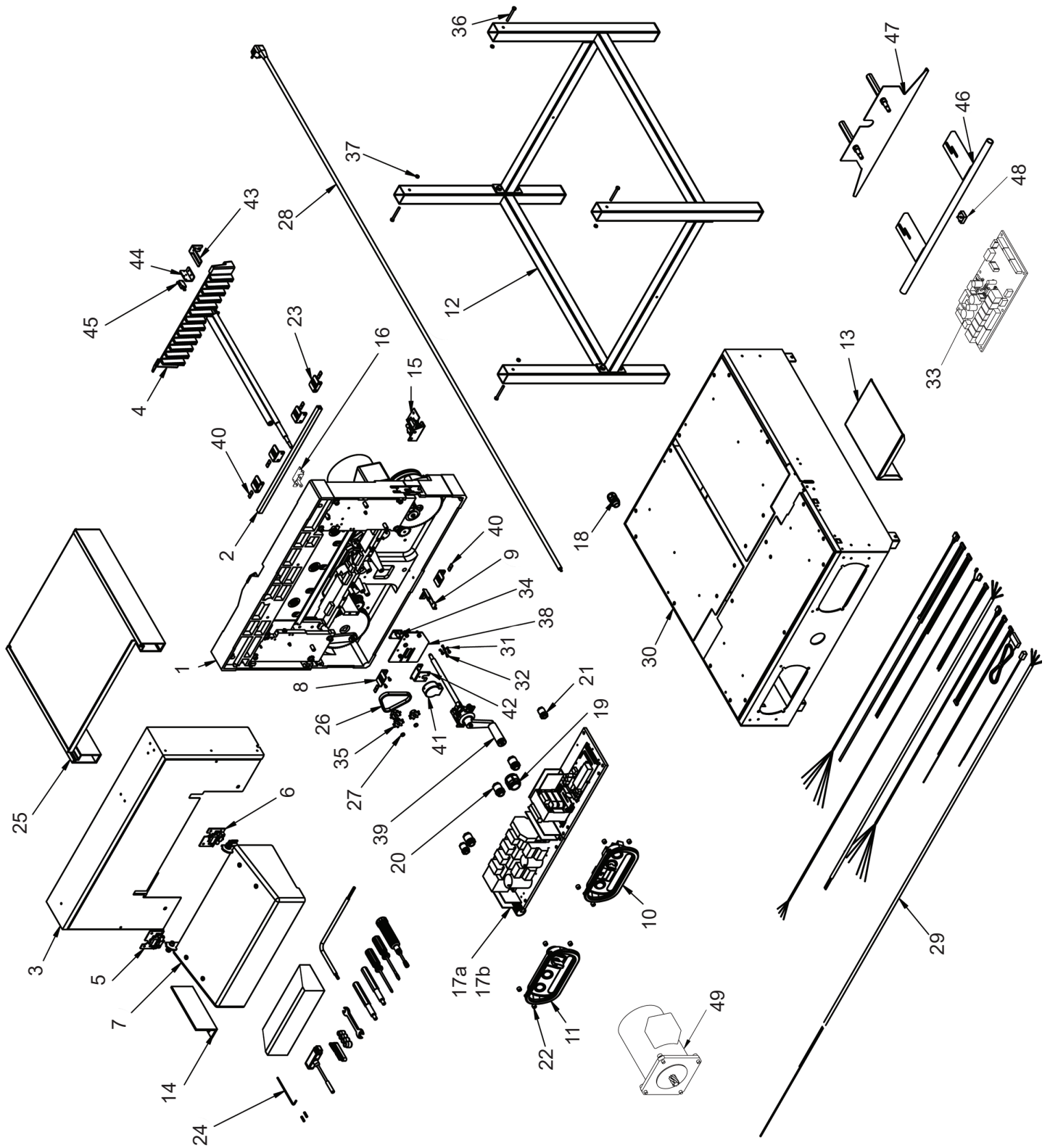

Fig. 10

PARTS



Item #	Part #	Description	Qty
1	89001	Cutter base set	1
2	27-20	Cutting stick (sold in box of 8)	1
3	89003	Cover	1
4	89004	Back gauge	1
5	89005	Front safety cover switch A	1
6	89006	Front safety cover switch B	1
7	89007	Front safety cover	1
8	89008	Fixer	4
9	89009	Ejector lever for cutting stick	1
10	89010	Control panel assembly - right	1
11	89011	Control panel assembly - left	1
12	89012	Stand assembly	1
13	89013	Side shelf	1
14	89014	Alignment guide - left	1
15	89015	Safety switch assembly	1
16	89016	LED laser head mount	1
17a	89017	Electronic unit	1
17b	88085	Transformer	1
18	89018	Cable fixer	1
19	89019	Connector BC34	1
20	89020	Connector A	3
21	89021	Connector B	2
22	89022	Bushing	8
23	89023	Fixer A	2
24	89024	Tool kit	1
25	89025	Side gauge with scale/rear cover	1
26	89026	Chain 410 1/2" 23P-292.IL	1
27	89027	Washer 5.4X0.8	2
28	89028	Cable	1

29	89029	Pin set	1
30	89030	Base set	1
31	89031	Washer 4.2	4
32	89032	Screw M4*10L	4
33	89033	IC board A	1
34	89034	Fixer	1
35	89035	Chain RS40-8T	3
36	89036	Screw M6X55L	4
37	89037	Screw nut	6
38	89038	Bearing mount	1
39	89039	Adjustment set	1
40	89040	Fixer	6
41	89041	Encoder	1
42	89042	Encoder mount	1
43	89043	Limiter	1
44	89044	Switch fixer	1
45	89045	Fine switch	1
46	89046	Front lifting handle	1
47	89047	Blade change tool	1
48	89048	Power conditioner - KBPC2560	1
49	89049	Motor	1
-	05800054	15 Amp Fuse	4
-	W05800120	3 Amp, 250VAC slow-blow fuse	2
50	W03301463	Fuse Mount	1
51	W01111706	Plastic spacer for bottom of back gauge	1
-	27-10	Replacement blade	1
-	KEY22/27	Replacement Key	1
-	05000066	IC with LED lights	2
n/a	51927	Blade Mounting Bolt Set - 27S	1

